

Web site: www.marinco.com

Phone: 800-307-6702

Date: July, 2011

Rev: 02

Flanged Inlet, straight
15A, 250V
2-Pole, 3-Wire

Catalog Number: 5678

- Item: Flanged Inlet, straight blade
- Rating: 15 amperes, 250 volts, NEMA Configuration 6-15P
- Materials: Device body and flange are nylon with CTI greater than 600 volts. Blades are solid brass.
- Terminals: Tempered brass, lug style, Perma-Lock™ design. Terminals visible through clear end cap.
- Terminal Identification: Terminal screws are color coded. Ground wire entrance hot stamped green and marked "GR."
- Listings: UL listed, File E57672
CSA certified, File LR81290
- Dimensions:

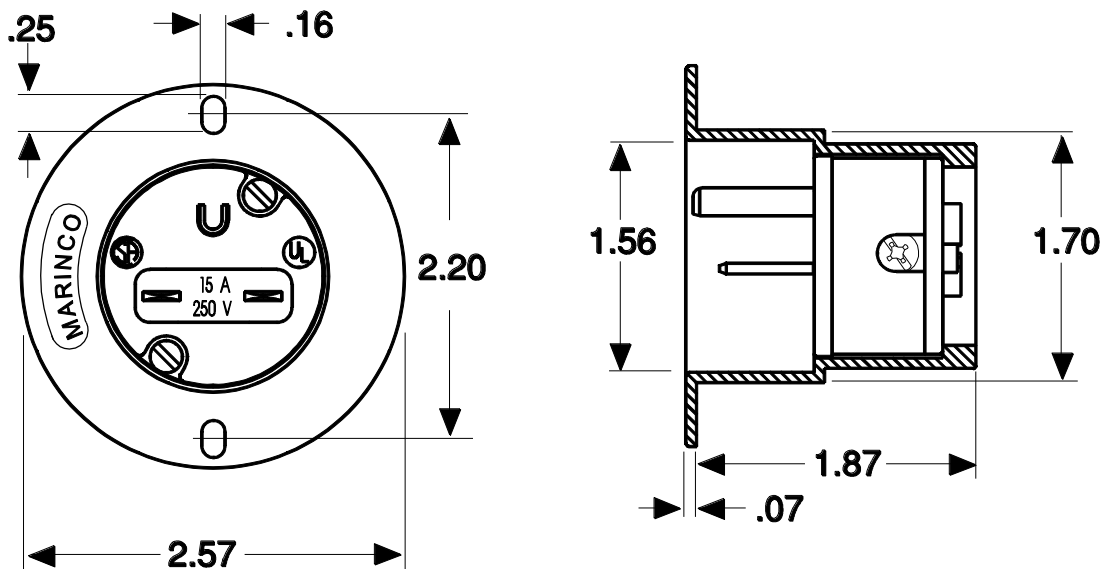

Dimensions shown in inches